

# Data Sheet



Article number: 021816011315

Description: Clamp with bracket and rubber  
SPGU 6011. 315/30 SK

## Measures

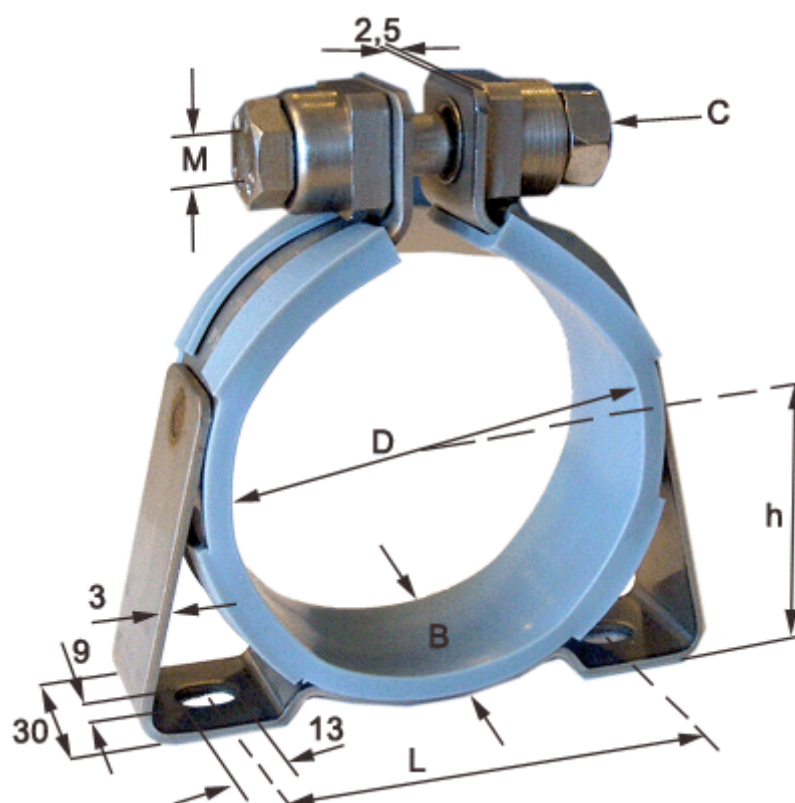

C (screw type) = SK hexagon screw

Diameter D = 315

h = 166

L = 280

Width B = 30